

ULTIMATE

PROFI



PROFESSIONAL LINE

PROFESSIONAL DISPLAY STAND
AND
MULTISCREEN CONSTRUCTION SYSTEMS

www.standsimulator.com

Installation



Bases

V Base Small

4 pcs of plastic feet included
Made of aluminium
For single side use
Wheels are not included
Color : Silver
Gross weight : 7,0 kg



H Base Small

4 pcs of plastic feet included
Made of aluminium
For double side use
Wheels are not included
Color : Silver
Gross weight : 8,0 kg



V Base Medium

4 pcs of plastic feet included
Made of aluminium
For single side use
Wheels are not included
Color : Silver
Gross weight : 7,50 kg



H Base Medium

4 pcs of plastic feet included
Made of aluminium
For double side use
Wheels are not included
Color : Silver
Gross weight : 8,60 kg



V Base Large

4 pcs of plastic feet included
Made of aluminium
For single side use
Wheels are not included
Color : Silver
Gross weight : 11,85 kg



H Base Large

4 pcs of plastic feet included
Made of aluminium
For double side use
Wheels are not included
Color : Silver
Gross weight : 12,60 kg



Flat Base

Solid body
Made of steel
For double side use
Color : Antracite
Gross weight : 18,5 kg



Center Base Small

Solid body
Made of steel
For double side use
Color : Antracite
Gross weight : 17,25 kg



Flat Base Maxi

Solid body
Made of steel
For double side use
Color : Antracite
Gross weight : 24,30 kg



Center Base Large

Solid body
Made of steel
For double side use
Color : Antracite
Gross weight : 23,0 kg



Fix Base

Made of steel and plastic cover
Easily mounted on the ground and the ceiling
Color : Black
Gross weight : 2,0 kg



Bars

Kit



Made of Steel + Plastic • Color : Antracite
• Product Weight : 0,70 kg

Bar - 480



Made of Aluminium • Color : Silver
Length : 48 cm • Product weight : 1,2 kg

Bar - 680



Made of Aluminium • Color : Silver
Length : 68 cm • Product weight : 1,60 kg

Bar - 880



Made of Aluminium • Color : Silver
Length : 88 cm • Product weight : 2,0 kg

Bar - 1200



Made of Aluminium • Color : Silver
Length : 120 cm • Product weight : 3,0 kg

Bar - 1900



Made of Aluminium • Color : Silver
Length : 190 cm • Product weight : 4,50 kg

Bar - 2200



Made of Aluminium • Color : Silver
Length : 220 cm • Product weight : 5,2 kg

Bar - 2850



Made of Aluminium • Color : Silver
Length : 285 cm • Product weight : 6,50 kg

Bar - 3250



Made of Aluminium • Color : Silver
Length : 325 cm • Product weight : 7,50 kg

Supports

- P-SPRT-400-STD**
- VESA 100X100 / 200X100 / 200X200 / 300X300 / 400X200 / 400X400
 - Made of Steel
 - Tilt Option + - 3 Degree
 - Height adjustable + - 5 mm
 - Montage screws System included
 - Plastic Lock System inside
 - Product Weight pair 3,20 Kg
 - Load Capability 60 Kg
 - Color : Antracite



- P-SPRT-600-STD**
- VESA 100X100 / 200X100 / 200X200 / 300X300 / 400X200 / 400X400 / 600X400
 - Made of Steel
 - Tilt Option + - 3 Degree
 - Height adjustable + - 5 mm
 - Montage screws System included
 - Plastic Lock System inside
 - Product Weight pair 4,50 Kg
 - Load Capability 60 Kg
 - Color : Antracite



- P-SPRT-400-MULTI**
- VESA 100X100 / 200X100 / 200X200 / 300X300 / 400X200 /
 - Made of Steel
 - Tilt Option + - 3 Degree
 - Height adjustable + - 5 mm
 - Plastic Lock System inside
 - Product Weight pair 4,80 Kg
 - Load Capability 45 Kg
 - Color : Antracite



- P-SPRT-600-MULTI**
- VESA 100X100 / 200X100 / 200X200 / 300X300 / 400X200 / 600X400
 - Made of Steel
 - Tilt Option + - 3 Degree
 - Height adjustable + - 5 mm
 - Plastic Lock System inside
 - Product Weight pair 6 Kg
 - Load Capability 45 Kg
 - Color : Antracite



- P-SPRT-400-POP-UP**
- VESA 100X100 / 200X100 / 200X200 / 300X300 / 400X200 / 400X400
 - Made of Steel
 - Unique Push To Open Design
 - Tilt-up feature for cabling
 - Product Weight pair 9,80 Kg
 - Load Capability 35 Kg
 - Color : Antracite



- P-SPRT-600-POP-UP**
- VESA 100X100 / 200X100 / 200X200 / 300X300 / 400X200 / 400X400 / 600X400
 - Made of Steel
 - Unique Push To Open Design
 - Tilt-up feature for cabling
 - Product Weight pair 10,50 Kg
 - Load Capability 35 Kg
 - Color : Antracite



Poles



- POLE-750**
- Made of Aluminium
 - Height : 75 cm
 - Color : Silver
 - Cable management both sides
 - Product Weight : 3,00 kg



- POLE-1100**
- Made of Aluminium
 - Height : 110 cm
 - Color : Silver
 - Cable management both sides
 - Product Weight : 4,50 kg



- POLE-1350**
- Made of Aluminium
 - Height : 135 cm
 - Color : Silver
 - Cable management both sides
 - Product Weight : 5,50 kg



- POLE-1500**
- Made of Aluminium
 - Height : 150 cm
 - Color : Silver
 - Cable management both sides
 - Product Weight : 6,15 kg



- POLE-1800**
- Made of Aluminium
 - Height : 180 cm
 - Color : Silver
 - Cable management both sides
 - Product Weight : 7,25 kg



- POLE-2000**
- Made of Aluminium
 - Height : 200 cm
 - Color : Silver
 - Cable management both sides
 - Product Weight : 8,10 kg

Carcass



Accessories

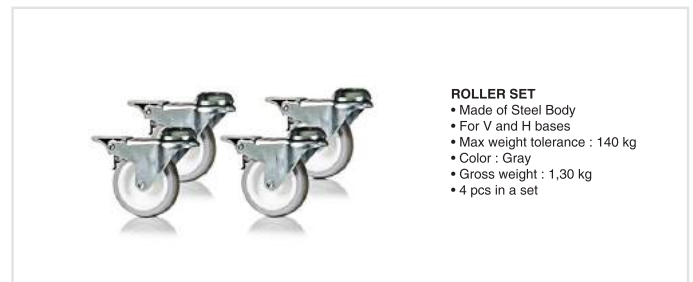

1 Displays

Single Side

Fix - 110



Vesa: 300x300 - 400x400 - 200x200 400x200
Bar: 48 cm | Pole : 110 cm
40'' - 52''

Fix Base

Fix - 135



Vesa: 300x300 - 400x400 - 200x200 400x200
Bar: 48 cm | Pole : 135 cm
40'' - 52''

Fix - 180



Vesa: 300x300 - 400x400 - 200x200 400x200
Bar: 48 cm | Pole : 180 cm
40'' - 52''

Mobil Base

(ROLLER SET is optional)

Mobil - 110



Vesa: 300x300 - 400x400 - 200x200 400x200
Bar: 48 cm | Pole : 110 cm
40'' - 52''

Mobil - 135



Vesa: 300x300 - 400x400 - 200x200 400x200
Bar: 48 cm | Pole : 135 cm
40'' - 52''

Mobil - 180



Vesa: 300x300 - 400x400 - 200x200 400x200
Bar: 48 cm | Pole : 180 cm
40'' - 52''

Flat Base

Flat - 110



Vesa: 300x300 - 400x400 - 200x200 400x200
Bar: 48 cm | Pole : 110 cm
40'' - 52''

Flat - 135



Vesa: 300x300 - 400x400 - 200x200 400x200
Bar: 48 cm | Pole : 135 cm
40'' - 52''

Flat - 180



Vesa: 300x300 - 400x400 - 200x200 400x200
Bar: 48 cm | Pole : 180 cm
40'' - 52''

Alternative :

	<p>Ceiling Mount</p>		<p>Wall Mount</p>
<p>Vesa: 300x300 - 400x400 - 200x200 400x200 Bar: 48 cm Pole : 110 cm 40'' - 52''</p>		<p>Vesa: 300x300 - 400x400 - 200x200 400x200 Bar: 48 cm 40'' - 52''</p>	

1 Displays

Single Side extended

Fix Base

Fix -E-110



Vesa: 300x300 - 400x400 - 600x400
200x200 - 400x200 Bar: 68 cm | Pole :110 cm
55'' - 65''

Fix -E-135



Vesa: 300x300 - 400x400 - 600x400
200x200 - 400x200 Bar: 68 cm | Pole :135 cm
55'' - 65''

Fix -E-180



Vesa: 300x300 - 400x400 - 600x400
200x200 - 400x200 Bar: 68 cm | Pole :180 cm
55'' - 65''

Mobil Base

(ROLLER SET is optional)

Mobil -E-110



Vesa: 300x300 - 400x400 - 600x400
200x200 - 400x200 Bar: 68 cm | Pole :110 cm
55'' - 65''

Mobil -E-135



Vesa: 300x300 - 400x400 - 600x400
200x200 - 400x200 Bar: 68 cm | Pole :135 cm
55'' - 65''

Mobil -E-180



Vesa: 300x300 - 400x400 - 600x400
200x200 - 400x200 Bar: 68 cm | Pole :180 cm
55'' - 65''

Flat Base

Flat -E-110



Vesa: 300x300 - 400x400 - 600x400
200x200 - 400x200 Bar: 68 cm | Pole :110 cm
55'' - 65''

Flat -E-135



Vesa: 300x300 - 400x400 - 600x400
200x200 - 400x200 Bar: 68 cm | Pole :135 cm
55'' - 65''

Flat -E-180



Vesa: 300x300 - 400x400 - 600x400
200x200 - 400x200 Bar: 68 cm | Pole :180 cm
55'' - 65''

Alternative :



Ceiling Mount

Vesa: 300x300 - 400x400 - 600x400 200x200 -
400x200 Bar: 68 cm | Pole :135 cm
55'' - 65''



Wall Mount

Vesa: 300x300 - 400x400 - 600x400 200x200 - 400x200
Bar: 68 cm 55'' - 65''





55'' - 65''

2 Displays

1x2



Components

 <p>Pole-1800 2 pcs</p> <ul style="list-style-type: none"> Made of aluminium Height : 180 cm Color : Silver Cable management both sides Product weight : 7,25 kg <p>V Base Large</p>  <p>4 pcs of plastic feet included Made of aluminium For single side use Wheels are not included Color : Silver Gross weight : 11,85 kg</p>	 <p>Support-400 2 pcs</p> <ul style="list-style-type: none"> VESA:100x100 / 200x100 / 200x200 / 300x300 / 400x200 / 400x400 Made of steel Tilt option + - 3 degree Montage screws system include Plastic lock system inside Product weight pair 3,20 Kg Color : Antracite <p>Kit 2 pcs</p>  <ul style="list-style-type: none"> Made of steel + Plastic Color : Antracite Product weight : 0,70 	 <p>Fix Base Flat Base</p> <p>Alternative Bases</p>
 <p>2 pcs Bar-1900 • Made of aluminium • Color : Silver • Length : 190 cm • Product weight : 4,50 kg</p>		

2 Displays

2x1



Components







 <p>Pole-1800 1 pcs</p> <ul style="list-style-type: none"> Made of aluminium Height : 180 cm Color : Silver Cable management both sides Product weight : 7,25 kg <p>Flat Base</p>  <p>Solid body Made of steel For double side use Color : Antracite Gross weight : 18,5 kg</p>	 <p>Support-400 2 pcs</p> <ul style="list-style-type: none"> VESA:100x100 / 200x100 / 200x200 / 300x300 / 400x200 / 400x400 Made of steel Tilt option + - 3 degree Montage screws system include Plastic lock system inside Product weight pair 3,20 Kg Color : Antracite <p>Kit 2 pcs</p>  <ul style="list-style-type: none"> Made of steel + Plastic Color : Antracite Product weight : 0,70 	 <p>Fix Base V Base</p> <p>Alternative Bases</p>
 <p>1 pcs Bar-480 • Made of aluminium • Color : Silver • Length : 48 cm • Product weight : 1,25 kg</p>		

3 Displays

1x3



Components



 <p>Pole-1800 <small>3 pcs</small></p> <ul style="list-style-type: none"> Made of aluminium Height : 180 cm Color : Silver Cable management both sides Product weight : 7,25 kg <p>Flat Base</p>  <p>Solid body Made of steel For double side use Color : Antracite Gross weight : 18,5 kg</p>	 <p>Support-400 <small>3 pcs</small></p> <ul style="list-style-type: none"> VESA:100x100 / 200x100 / 200x200 / 300x300 / 400x200 / 400x400 Made of steel Tilt option + - 3 degree Montage screws system include Plastic lock system inside Product weight pair 3,20 Kg Color : Antracite  <p>Kit <small>3 pcs</small></p> <ul style="list-style-type: none"> Made of steel + Plastic Color : Antracite Product weight : 0,70 	 <p>Fix Base V Base</p>
 <p><small>1 pcs</small> Bar-2850 • Made of aluminium • Color : Silver • Length : 285 cm • Product weight : 6,50 kg</p>		<p>Alternative Bases</p>

3 Displays

3x1



Components

 <p>Pole-2000 <small>1 pcs</small></p> <ul style="list-style-type: none"> Made of aluminium Height : 200 cm Color : Silver Cable management both sides Product weight : 8,10 kg <p>Fix Base</p>  <p>Made of steel and plastic cover Easily mounted on the ground and the ceiling Color : Black Gross weight : 2,0 kg</p>	 <p>Support-400 <small>3 pcs</small></p> <ul style="list-style-type: none"> VESA:100x100 / 200x100 / 200x200 / 300x300 / 400x200 / 400x400 Made of steel Tilt option + - 3 degree Montage screws system include Plastic lock system inside Product weight pair 3,20 Kg Color : Antracite  <p>Kit <small>3 pcs</small></p> <ul style="list-style-type: none"> Made of steel + Plastic Color : Antracite Product weight : 0,70 	
 <p><small>3 pcs</small> Bar-680 • Made of aluminium • Color : Silver • Length : 68 cm • Product weight : 1,60 kg</p>		

4 Displays

2x2



Components

<p>Pole-1800 <small>2 pcs</small></p> <ul style="list-style-type: none"> Made of aluminium Height : 180 cm Color : Silver Cable management both sides Product weight : 7,25 kg <p>V Base Large</p>  <p>4 pcs of plastic feet included Made of aluminium For single side use Wheels are not included Color : Silver Gross weight : 11,85 kg</p>	<p>Support-400 <small>4 pcs</small></p> <ul style="list-style-type: none"> VESA:100x100 / 200x100 / 200x200 / 300x300 / 400x200 / 400x400 Made of steel Tilt option + - 3 degree Montage screws system include Plastic lock system inside Product weight pair 3,20 Kg Color : Antracite <p>Kit <small>4 pcs</small></p> <ul style="list-style-type: none"> Made of steel + Plastic Color : Antracite Product weight : 0,70
<p>Bar-1900 <small>2 pcs</small> • Made of aluminium • Color : Silver • Length : 190 cm • Product weight : 4,50 kg</p> 	



Alternative Bases

4 Displays

Back to Back

1x2



Components

<p>Pole-1800 <small>2 pcs</small></p> <ul style="list-style-type: none"> Made of aluminium Height : 180 cm Color : Silver Cable management both sides Product weight : 7,25 kg <p>H Base Large</p>  <p>4 pcs of plastic feet included Made of aluminium For double side use Wheels are not included Color : Silver Gross weight : 12,60 kg</p>	<p>Support-400 <small>4 pcs</small></p> <ul style="list-style-type: none"> VESA:100x100 / 200x100 / 200x200 / 300x300 / 400x200 / 400x400 Made of steel Tilt option + - 3 degree Montage screws system include Plastic lock system inside Product weight pair 3,20 Kg Color : Antracite <p>Kit <small>4 pcs</small></p> <ul style="list-style-type: none"> Made of steel + Plastic Color : Antracite Product weight : 0,70
<p>Bar-1900 <small>2 pcs</small> • Made of aluminium • Color : Silver • Length : 190 cm • Product weight : 4,50 kg</p> 	



Alternative Bases

4 Displays

Back to Back

2x1



Components

 <p>Pole-1800 1 pcs</p> <ul style="list-style-type: none"> Made of aluminium Height : 180 cm Color : Silver Cable management both sides Product weight : 7,25 kg <p>Fix Base</p>  <p>Made of steel and plastic cover Easily mounted on the ground and the ceiling Color : Black Gross weight : 2,0 kg</p>	 <p>Support-400 4 pcs</p> <ul style="list-style-type: none"> VESA:100x100 / 200x100 / 200x200 / 300x300 / 400x200 / 400x400 Made of steel Tilt option + - 3 degree Montage screws system include Plastic lock system inside Product weight pair 3,20 Kg Color : Antracite <p>Kit 4 pcs</p>  <ul style="list-style-type: none"> Made of steel + Plastic Color : Antracite Product weight : 0,70 	 <p>Center Base H Base</p>
 <p>4 pcs Bar-480 • Made of aluminium • Color : Silver • Length : 48 cm • Product weight : 1,25 kg</p>		<p>Alternative Bases</p>

6 Displays

2x3

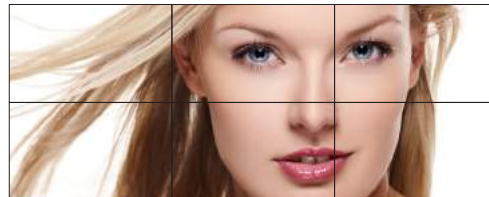

Components



 <p>Pole-2000 3 pcs</p> <ul style="list-style-type: none"> Made of aluminium Height : 200 cm Color : Silver Cable management both sides Product Weight : 8,10 kg <p>V Base Small</p>  <p>4 pcs of plastic feet included Made of aluminium For single side use Wheels are not included Color : Silver Gross weight : 7,0 kg</p>	 <p>Support-400 6 pcs</p> <ul style="list-style-type: none"> VESA:100x100 / 200x100 / 200x200 / 300x300 / 400x200 / 400x400 Made of steel Tilt option + - 3 degree Montage screws system include Plastic lock system inside Product weight pair 3,20 Kg Color : Antracite <p>Kit 6 pcs</p>  <ul style="list-style-type: none"> Made of steel + Plastic Color : Antracite Product weight : 0,70 	 <p>Fix Base Flat Base</p>
 <p>2 pcs Bar-2850 • Made of aluminium • Color : Silver • Length : 285 cm • Product weight : 6,50 kg</p>		<p>Alternative Bases</p>

6 Displays

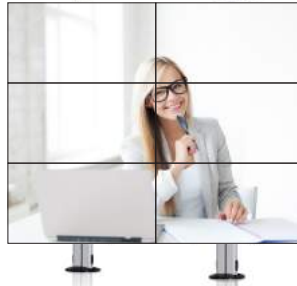
3x2



Components

<p>Pole-2000 <small>2 pcs</small></p> <ul style="list-style-type: none"> Made of aluminium Height : 200 cm Color : Silver Cable management both sides Product weight : 8,10 kg <p>Fix Base</p>  <p>Made of steel and plastic cover Easily mounted on the ground and the ceiling Color : Black Gross weight : 2,0 kg</p>	<p>Support-400 <small>6 pcs</small></p> <ul style="list-style-type: none"> VESA:100x100 / 200x100 / 200x200 / 300x300 / 400x200 / 400x400 Made of steel Tilt option + - 3 degree Montage screws system include Plastic lock system inside Product weight pair 3,20 Kg Color : Antracite <p>Kit <small>6 pcs</small></p> <ul style="list-style-type: none"> Made of steel + Plastic Color : Antracite Product weight : 0,70 	 <p>V Base Flat Base</p> <p>Alternative Bases</p>
<p>3 pcs Bar-1900 • Made of aluminium • Color : Silver • Length : 190 cm • Product weight : 4,50 kg</p> 		



6 Displays

Back to Back

1x3



Components

<p>Pole-1800 <small>3 pcs</small></p> <ul style="list-style-type: none"> Made of aluminium Height : 180 cm Color : Silver Cable management both sides Product weight : 7,25 kg <p>Fix Base</p>  <p>Made of steel and plastic cover Easily mounted on the ground and the ceiling Color : Black Gross weight : 2,0 kg</p>	<p>Support-400 <small>6 pcs</small></p> <ul style="list-style-type: none"> VESA:100x100 / 200x100 / 200x200 / 300x300 / 400x200 / 400x400 Made of steel Tilt option + - 3 degree Montage screws system include Plastic lock system inside Product weight pair 3,20 Kg Color : Antracite <p>Kit <small>6 pcs</small></p> <ul style="list-style-type: none"> Made of steel + Plastic Color : Antracite Product weight : 0,70 	 <p>Center Base H Base</p> <p>Alternative Bases</p>
<p>2 pcs Bar-2850 • Made of aluminium • Color : Silver • Length : 285 cm • Product weight : 6,50 kg</p> 		

3x1

6 Displays

Back to Back



Components

<p>Pole-2000 <small>2 pcs</small></p> <ul style="list-style-type: none"> Made of aluminium Height : 200 cm Color : Silver Cable management both sides Product weight : 8,10 kg <p>H Base Medium</p>  <p>4 pcs of plastic feet included Made of aluminium For double side use Wheels are not included Color : Silver Gross weight : 8,60 kg</p>	<p>Support-400 <small>6 pcs</small></p> <ul style="list-style-type: none"> VESA:100x100 / 200x100 / 200x200 / 300x300 / 400x200 / 400x400 Made of steel Tilt Option + - 3 degree Montage screws system include Plastic lock system inside Product weight pair 3,20 Kg Color : Antracite
<p><small>6 pcs</small> Bar-680 • Made of aluminium • Color : Silver • Length : 68 cm • Product weight : 1,60 kg</p> 	<p>Kit <small>6 pcs</small></p> <ul style="list-style-type: none"> Made of steel + Plastic Color : Antracite Product weight : 0,70 





Alternative Bases

8 Displays

2x4



Components

<p>Pole-1800 <small>4 pcs</small></p> <ul style="list-style-type: none"> Made of aluminium Height : 180 cm Color : Silver Cable management both sides Product weight : 7,25 kg <p>V Base Small</p>  <p>4 pcs of plastic feet included Made of aluminium For single side use Wheels are not included Color : Silver Gross weight : 7,0 kg</p>	<p>Support-400 <small>8 pcs</small></p> <ul style="list-style-type: none"> VESA:100x100 / 200x100 / 200x200 / 300x300 / 400x200 / 400x400 Made of steel Tilt option + - 3 degree Montage screws system include Plastic lock system inside Product weight pair 3,20 Kg Color : Antracite
<p><small>4 pcs</small> Bar-2200 • Made of aluminium • Color : Silver • Length : 220 cm • Product weight : 5,20 kg</p> 	<p>Kit <small>8 pcs</small></p> <ul style="list-style-type: none"> Made of steel + Plastic Color : Antracite Product weight : 0,70 



Alternative Bases

8 Displays

Back to Back

2x2



Components



<p>Pole-1800 <small>2 pcs</small></p> <ul style="list-style-type: none"> Made of aluminium Height : 180 cm Color : Silver Cable management both sides Product weight : 7,25 kg <p>H Base Large</p>  <p>4 pcs of plastic feet included Made of aluminium For double side use Wheels are not included Color : Silver Gross weight : 12,60 kg</p>	<p>Support-400 <small>8 pcs</small></p> <ul style="list-style-type: none"> VESA:100x100 / 200x100 / 200x200 / 300x300 / 400x200 / 400x400 Made of steel Tilt option + - 3 degree Montage screws system include Plastic lock system inside Product weight pair 3,20 Kg Color : Antracite <p>Kit <small>8 pcs</small></p> <ul style="list-style-type: none"> Made of steel + Plastic Color : Antracite Product weight : 0,70 	 <p>Fix Base Center Base</p> <p>Alternative Bases</p>
<p>Bar-1900 <small>4 pcs</small> • Made of aluminium • Color : Silver • Length : 190 cm • Product weight : 4,50 kg</p> 		

9 Displays

3x3



Components

<p>Pole-2000 <small>3 pcs</small></p> <ul style="list-style-type: none"> Made of aluminium Height : 200 cm Color : Silver Cable management both sides Product weight : 8,10 kg <p>Fix Base</p>  <p>Made of steel and plastic cover Easily mounted on the ground and the ceiling Color : Black Gross weight : 2,0 kg</p>	<p>Support-400 <small>9 pcs</small></p> <ul style="list-style-type: none"> VESA:100x100 / 200x100 / 200x200 / 300x300 / 400x200 / 400x400 Made of steel Tilt option + - 3 degree Montage screws system include Plastic lock system inside Product weight pair 3,20 Kg Color : Antracite <p>Kit <small>9 pcs</small></p> <ul style="list-style-type: none"> Made of steel + Plastic Color : Antracite Product weight : 0,70 	 <p>V Base Flat Base</p> <p>Alternative Bases</p>
<p>Bar-2850 <small>3 pcs</small> • Made of Aluminium • Color : Silver • Length : 285 cm • Product Weight : 6,50 kg</p> 		



ULTIMATE

PROFESSIONAL DISPLAY STAND
AND
MULTISCREEN CONSTRUCTION SYSTEMS



www.standsimulator.com



BERLIN



BARCELONA

PROFI



ULTIMATE



Eralp GROUP
Inonu Mah 150 sok No:11
Ayrancilar / Torbali / Izmir / TURKEY

Telefon : 0090-232-8548050
Telefax : 0090-232-8548011
www.eralpgroup.com



www.standsimulator.com